

Undercounters

Back Mounted Condensing Unit

Owner's Manual

ETBR1, ETBSR2, ETBR2, ETBWR2, ETBR3,
ETBF1, ETBSF2, ETBF2, ETBWF2, ETBF3
ETBR1-D2, ETBSR2-D2, ETBR2-D4,
ETBWR2-D4, ETBR3-D2



www.everestref.com

Undercounters Back Mounted Condensing Unit

ETBR1, ETBSR2, ETBR2, ETBWR2, ETBR3, ETBF1, ETBSF2, ETBF2, ETBWF2, ETBF3,
ETBR1-D2, ETBSR2-D2, ETBR2-D4, ETBWR2-D4, ETBR3-D2

Contents

1. Hydrocarbon Guidelines	1
2. Installation Instructions	3
3. General Safety	7
4. Electrical Safety	8
5. Operation	9
6. Care and Maintenance	14
7. Troubleshooting Guide	17
8. Warranty Information	19



1. Hydrocarbon Guidelines

This section applies to R290 Hydrocarbon units only. To identify the refrigerant type, see the data plate in the cabinet interior.

WARNING - THIS UNIT USES R290, A HYDROCARBON, PROPANE REFRIGERANT THAT IS ENVIRONMENTALLY FRIENDLY BUT IS ALSO HIGHLY FLAMMABLE AND EXPLOSIVE. PLEASE READ THIS MANUAL CAREFULLY AND FOLLOW ALL SAFETY PRECAUTIONS CONTAINED HEREIN TO AVOID THE RISK OF FIRE OR EXPLOSION. FAILURE TO FOLLOW THE SAFETY PRECAUTIONS MAY RESULT IN SERIOUS INJURY OR DEATH, AND/OR PROPERTY DAMAGE.

DANGER - Risk of fire or explosion. Flammable refrigerant used. Do not use mechanical devices or other means to accelerate the defrosting process. Do not puncture refrigerant tubing.

DANGER - Risk of fire or explosion. Flammable refrigerant used. To be repaired only by trained service personnel. Do not puncture refrigerant tubing.

CAUTION - Risk of fire or explosion. Flammable refrigerant used. Consult Service Manual or Owner's Manual before attempting to install or service this product. All safety precautions must be followed.

CAUTION - Risk of fire or explosion. Dispose of properly in accordance with federal or local regulations. Flammable refrigerant used.

CAUTION - Risk of fire or explosion due to puncture of refrigerant tubing; follow handling instructions carefully. Flammable refrigerant used.

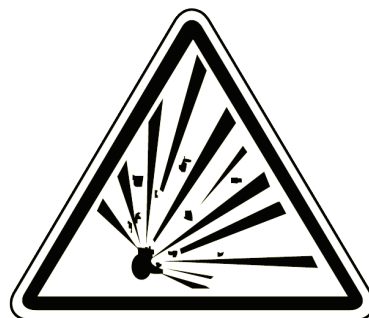

Propane (R290) is highly approved for use as a refrigerant in commercial, self-contained units in the US under limited use conditions. It can only be used in new equipment. Backfitting or modifications of old equipment are not allowed. It must be charged in a strictly limited volume of up to 150 grams (5.3 oz) per refrigeration circuit. Even though this is a small amount, it still presents a fire or explosion hazard if it leaks out of parts that hold refrigerant. When it comes in contact with air, a flammable propane-air mixture can be created and easily ignited by electrical sparks, open flames or hot surfaces. The risk is higher in small, confined, poorly ventilated spaces. Propane will settle at lower zones because it is heavier than air. To reduce these risks, observe the following precautions

- Avoid installation of unit in areas with open flames or in general vicinity of open flames or high surface temperatures.
- Avoid unit installation in small, confined spaces. Ensure ample ventilation at all times. Keep all exhaust vents free of any blockage or obstruction.
- Do not rely on smell to detect potential leaks of propane refrigerant. Propane refrigerant is a high purity propane gas and does not contain odourants or stenching agents. These additives are typically used in fuel-grade propane and natural gas in order to give them a distinctive smell which makes it easier to detect leaks.
- General service and repairs must be performed in well-ventilated areas. General service and repairs must be performed only by professionals authorized by Everest Refrigeration.
- Component shall be replaced with Everest-issued, like components to minimize the risk of possible ignition resulting from incompatible parts or improper repairs.
- Do not modify, re-appropriate or remove any functional part(s) from the unit.
- Handle the unit with care to avoid any damage.
- Practice safety guidelines when transporting the unit. Consult with your local Department of Transportation for requirements in moving flammable gasses.

2. Installation Instructions

This section applies to all Everest products. Correct installation ensures proper performance and longevity of your appliance. Professional installation by a trained refrigeration technician and electrician is recommended. Warranty is void if the following guidelines are not met.

- 1.** Inspect for any freight damage upon delivery of the unit. If damage is detected, immediately report it to an Everest representative. Everest is not responsible for damage that occurs during shipment.
- 2.** Keep the unit upright at all times. The compressor contains oil, refrigerant, lubricants and various chemicals. When tilted, these fluids may shift and travel to sections where they don't naturally occur. This will lead to system contamination and compressor failure.
- 3.** Some units require caster installation for proper performance. Visit our website at www.everestref.com and enter your product's model number in the search field to determine its caster requirements.
- 4.** Do not place your hands under the unit when moving it to avoid injury from sharp edges, protruding parts or weight impact.
- 5.** Select a location with good air ventilation. Poor ventilation rapidly increases ambient temperature. High ambient temperatures exceeding 86°F (30°C) promote excessive compressor activity in order to maintain the desired cabinet temperature. This will result in decreased performance, advanced component failure and the risk of fire.
- 6.** Select a location away from heat-generating equipment such as stoves, ovens, etc. Heat sources rapidly increase the temperature of the immediate vicinity. High temperatures exceeding 86°F (30°C) promote excessive compressor activity in order to maintain the desired cabinet temperature. This will result in decreased performance, advanced component failure, and the risk of fire.
- 7.** A distance of 6" is required for back side and right side clearance. This ensures proper ventilation and prevents overheating which can lead to advanced component failure and the risk of fire.
- 8.** Select a location with a hard, leveled surface. Use a leveling tool on the unit to ensure proper alignment. Proper door function and condensate removal is dependent on accurate balance. Install the front leg stabilizers for units that come standard with it to ensure proper door / drawer functions and unit stability.
- 9.** Select a location close to an electrical wall outlet to ensure direct connection without the use of extension cords.
- 10.** Select a location away from severe moisture conditions. This may compromise the unit's electrical components and lead to electrical shocks or the risk of fire.
- 11.** Select a location that will not expose the unit to extremely dusty conditions. Environments with high dust and debris content will significantly hasten condenser coil and condenser coil air filter blockage and will result in decreased performance, advanced component failure and the risk of fire.
- 12.** Do not build an enclosure or cabinet around the unit. This will restrict air ventilation resulting in elevated compressor activity, decreased performance, advanced component failure and the risk of fire.
- 13.** The unit is not intended for use in food trucks. Limited space, lack of ventilation and ambient temperatures exceeding 86°F (30°C) typical to this setting will result in elevated compressor activity, decreased performance, advanced component failure and the risk of fire.
- 14.** The unit is intended for indoor use only. Outdoor use will cause a decrease in performance, advanced component failure and the risk of fire.

Shelf Installation

Some models come standard with shelves, shelf clips and notched pilasters. Each shelf requires four clips.

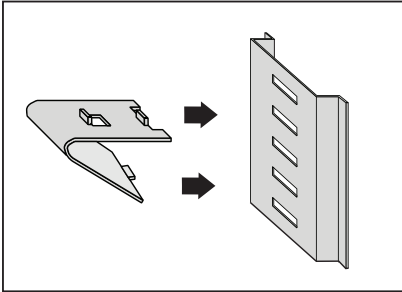

1. Attach the shelf clips onto the pilasters by inserting its top hook into a pilaster notch followed by the bottom hook. Do not use pliers or other crimping tools to modify the shape of the shelf clips. This will result in shelf mounting instability.

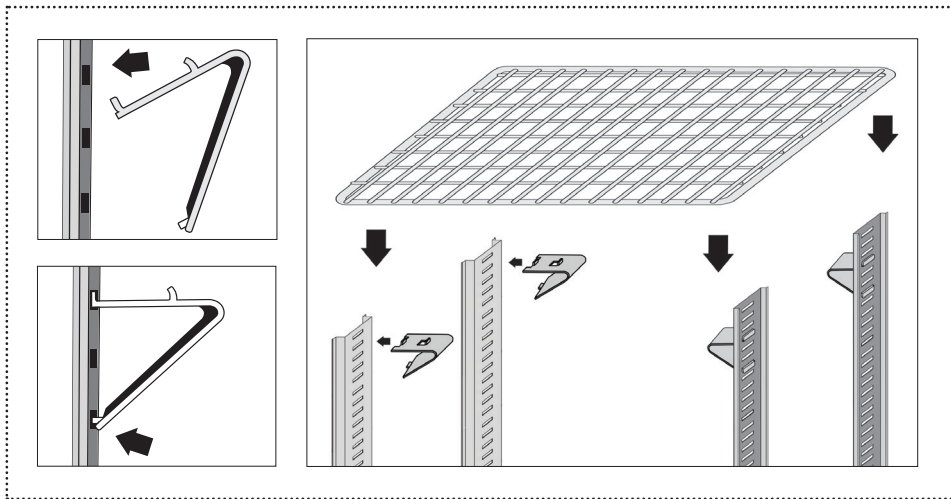

2. Place shelves on the shelf clips making sure all corners are mounted securely and evenly with identical distance from the unit's floor and up. Always lay the back of each shelf down on the rear clips before the front.

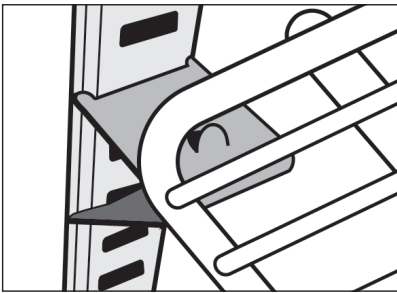

3. When removing a shelf, unmount the shelf from the shelf clips. To detach the shelf clip from the pilaster, tilt up the shelf clip until the bottom hook clears, followed by the top hook.

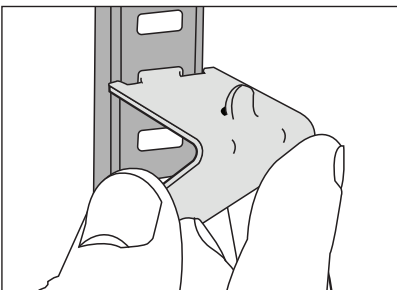

Product Load Level

ETB Series (Solid Door Models)

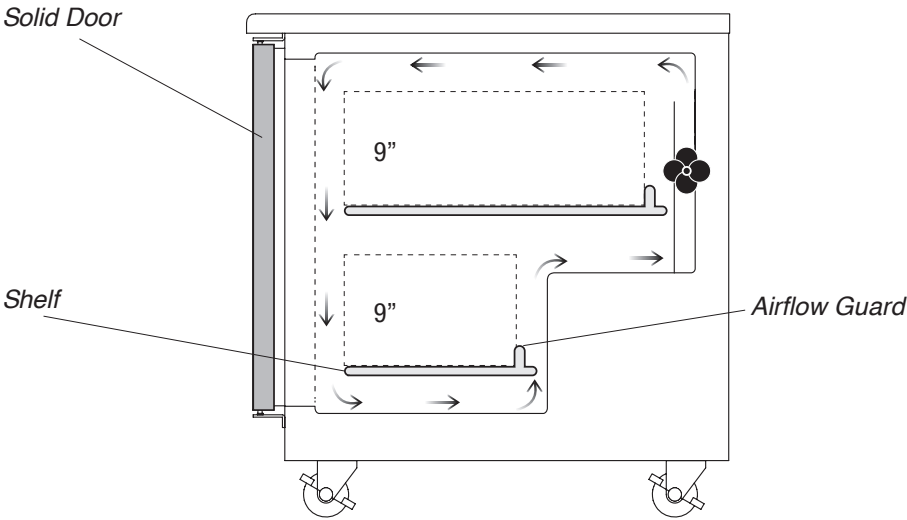
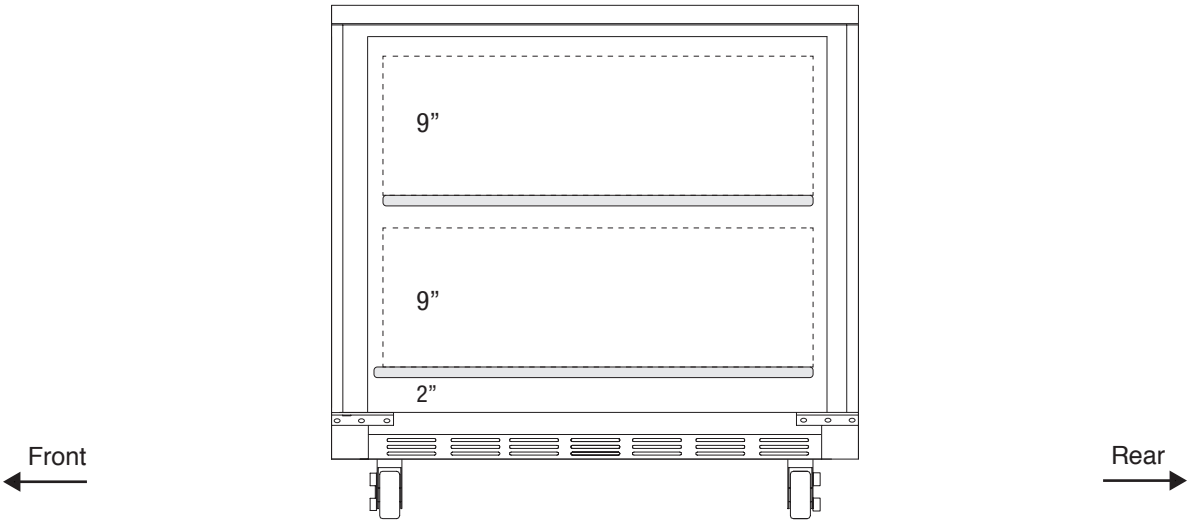

Pan Configurations

Drawered Undercounter

Some models come with drawers. Drawer pans are not included with the product as standard and must be purchased separately.

ETBR1-D2

[Standard: (1) pan divider per drawer included]



Top Drawer
Pan Depth 4"



Bottom Drawer
Pan Depth 6"

ETBWR2-D4

[Standard: (2) pan dividers per drawer included]

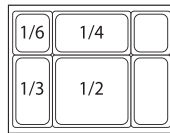

Top Drawer
Pan Depth 4"

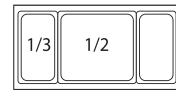

Bottom Drawer
Pan Depth 6"

ETBSR2-D2

[Standard: (2) pan dividers per drawer included]

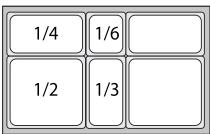

Top Drawer
Pan Depth 4"



Bottom Drawer
Pan Depth 6"

ETBR3-D2

[Standard: (4) pan dividers per drawer included]

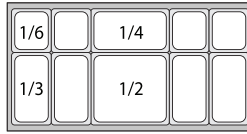

Top Drawer
Pan Depth 4"



Bottom Drawer
Pan Depth 6"

ETBR2-D4

[Standard: (1) pan divider per drawer included]

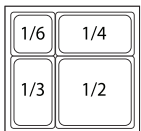

Top Drawer
Pan Depth 4"

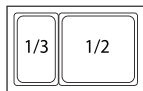

Bottom Drawer
Pan Depth 6"

* Custom pan dividers required to fit standard full sized pans. Contact manufacturer for details.

3. General Safety

This section applies to all Everest products. Use your appliance according to its designed function as specified in this Owner's Manual. Warranty is void if the following guidelines are not met.

- Before the unit is used, it must be installed and connected according to the installation instructions provided in this manual.
- Remove all packaging material and protective vinyl covering from the unit before it is used. These items are flammable and can lead to a fire.
- Do not store or use gasoline or other flammable vapors and liquids in the vicinity of the unit. Do not store combustible or explosive items and substances such as aerosol cans in or around the vicinity of the unit.
- Do not place objects on or around the exhaust vents of the unit. This can cause overheating which may lead to a fire or explosion. Objects may also fall when opening and closing doors which may lead to serious injury.
- Do not climb, stand or hang on the shelves, doors or drawers of the unit. This can damage the unit and lead to serious injury.
- Do not touch the freezer interior if your hands are wet or damp. This may lead to freezer burn or cause your skin to stick to the cold surface.
- If you suspect a refrigerant leak or a compromised refrigeration system, disconnect the unit and contact Everest Refrigeration immediately.
- When disposing the unit, remove all doors and shelves to avoid any risk of injury or entrapment. Ensure that the refrigerant in the condensing unit is properly disposed of by a qualified refrigeration technician according to governmental codes, requirements and regulations.



4. Electrical Safety

This section applies to all Everest products. Basic safety precautions must be observed when using electrical appliances in addition to the following. Warranty is void if these guidelines are not met.

Everest units come as 115 volts, 60 hertz, single phase.

Everest units in this family are equipped with a NEMA 5-15P. A 15 amp breaker must be used for units that come with a NEMA 5-15P plug.



The ground prong must not be removed to reduce the risk of electric shock and related hazards. If the grounding pin is missing, the cord must be removed from use. If the outlet is a standard 2-prong outlet, it must be replaced with the properly grounded 3-prong wall outlet. Only a qualified electrician may install the correct power source.

To guarantee electrical safety, the wall outlet and circuit must be checked by a qualified electrician to make sure it is properly grounded.

Remove debris from the power plug prongs with a soft cloth or brush before connecting it to an outlet.

Assign the unit to a dedicated, undamaged electrical circuit with a voltage rating that matches the data plate. Check the incoming voltage with a multi-meter. This avoids the overloading and overheating of circuit wires which may lead to a fire.

Do not use extension cords, adapter plugs or other third party electrical connections. Everest is not responsible for issues resulting from improper electrical connections, electrical power failures and voltage fluctuations.

Everest does not recommend the use of generators in conjunction with the unit due to voltage fluctuations that may compromise electrical components.

Turn off the unit using the power button before unplugging. Wait at least 5 minutes before re-plugging to prevent damage to the compressor.

Do not unplug the unit by tugging on the power cord. Grip the plug and pull it securely out of the outlet.

Prevent damage to the power cord by providing sufficient clearance around and under the unit. Do not use a power cord that shows cracks or exposed wires. Power cords that have been severely worn or damaged must be replaced with original manufacturer parts and only by an authorized technician.

5. Operation

Use your Everest product according to its intended functions. Warranty is void if the following guidelines are not met.

Starting your Everest Product

After plugging in the unit, the current temperature and compressor symbol will appear on the digital temperature control's LED display.  will flash at short intervals for 1 minute after which the compressor(s) and condenser fan motor(s) will initiate. At the beginning of every compressor cycle, the condenser fan motor is automated to rotate in reverse for 30 seconds in order to blow dust off the condenser coil.

The evaporator fan motor(s) will initiate once the evaporator coil reaches a specific temperature relative to the digital temperature control setting and for as long as the door is closed. A fan symbol  will appear on the LED display to indicate that the evaporator fan is running.

Allow the unit to operate for 24 to 72 hours before storing contents in the cabinet. This lets the cabinet temperature fully stabilize. Use this time to verify proper installation and operation.

The interior light and evaporator fan motor is controlled by a door switch for solid door models and a rocker switch for glass door models.

The default temperature setting is 35.0°F (2.0°C) for refrigerators and -4.0°F (-20.0°C) for freezers. The factory recommended temperature range is between 33.0°F (1.0°C) to 40.0°F (4.0°C) for refrigerators and -5.0°F (-21.0°C) to 0°F (-18.0°C) for freezers. Setting the temperature outside of the recommended range will cause performance issues and in some cases may result in component failure that is outside of warranty coverage.

The compressor, condenser and evaporator fan motors run while the unit is on refrigeration cycle.

The compressor, condenser and evaporator fan motors stop running while the unit is on defrost cycle.

The unit is preset to defrost every 5-6 hours with a duration of 45 minutes or less depending on the evaporator coil temperature. Changing the preset outside of the default range will result in cooling issues and advanced component failure.

The digital temperature control is intended to read and display the cabinet's air temperature, not actual food product temperature. The displayed temperature may fluctuate due to frequent or prolonged door operation. The most conclusive method to determine a unit's cooling performance is to measure the food product's temperature using a digital food thermometer.

Carel 'Easy' Digital Temperature Control

Everest units are equipped with a Carel Digital Temperature Control. The type of controller is dependent on the model and production date.

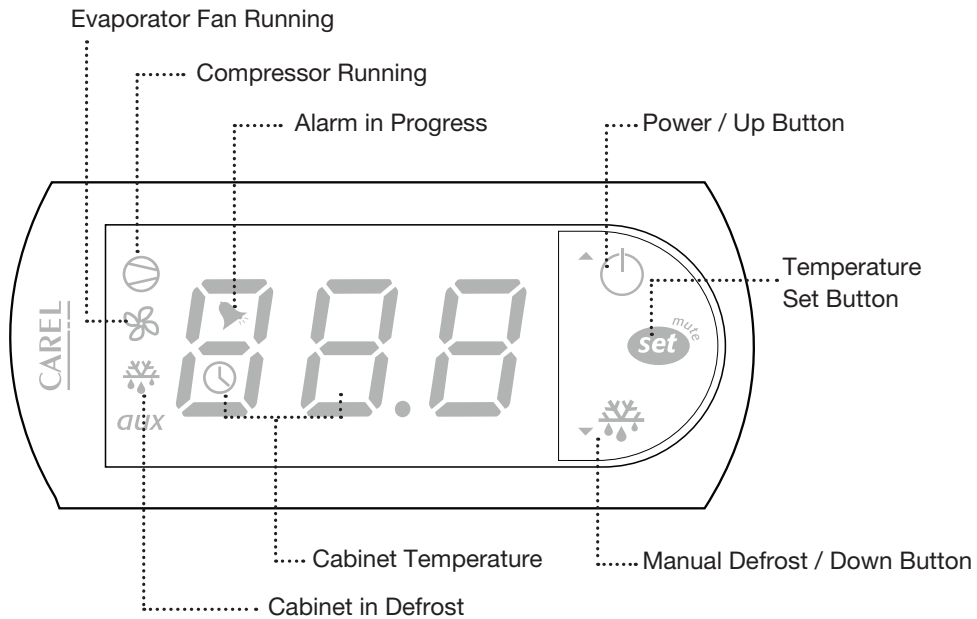

Setting the Temperature

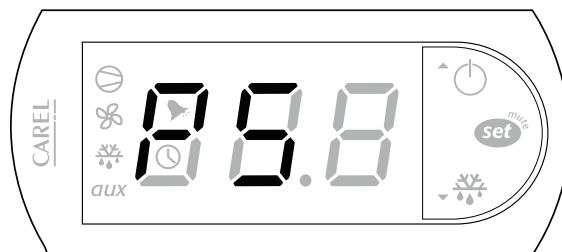

1. Press and hold Temperature Set Button **set** for 2 seconds until the LED blinks SET **888** alternating with a number. The blinking number is the current set temperature.

CAUTION: If PS appears on the LED



This means the Temperature Set button **set** was held down longer than 3 seconds. To exit this mode and restart, press Temperature Set Button **set**

Setting the Temperature (continued)

2. Toggle through the desired temperature by pressing UP  or DOWN . The number increases or decreases by a decimal point.

3. The recommended setting is 35.0°F (2.0°C) for refrigerators and -4.0°F (-20.0°C) for freezers. The available temperature setting range is 33.0°F to 54.0°F (1.0°C to 12.0°C) for Refrigerators and -10.0°F to 54.0°F (-23.0°C to 12.0°C) for Freezers.

4. Press and hold the Temperature Set Button  for 3 seconds to save the new temperature and exit the setting mode. The LED will return to the current cabinet temperature.

Initiating Manual Defrost

The controller has an automatic defrost cycle in place so initiating manual defrost is not necessary unless there is an abnormal accumulation of ice around the evaporator coil.

1. Press and hold down the Manual Defrost Button  until the Defrost Symbol  appears on the LED display.

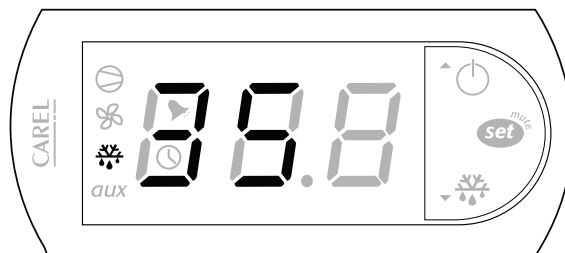



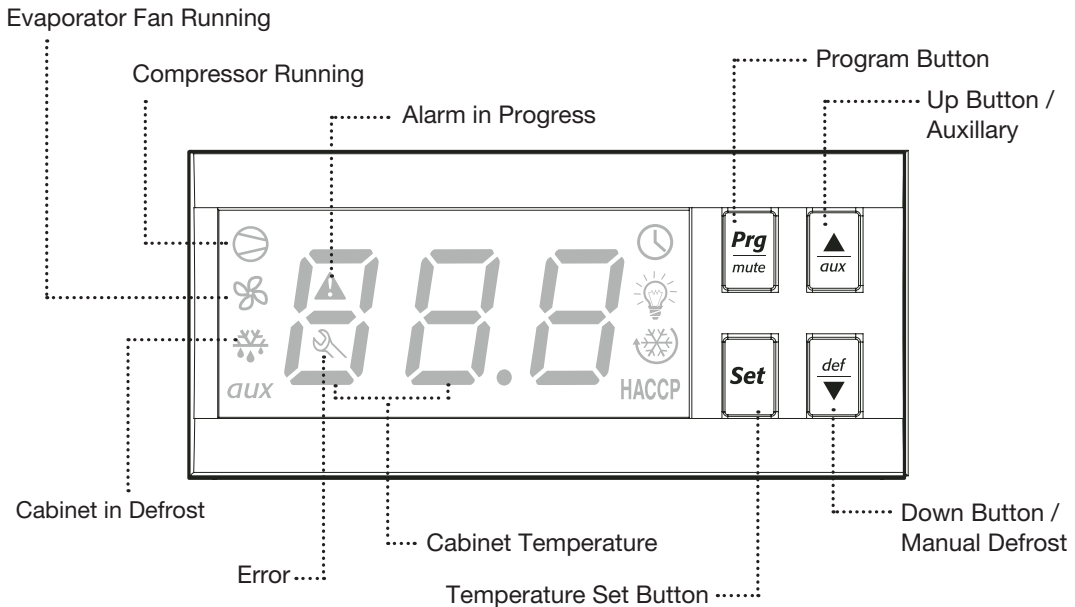

The compressor, condenser and evaporator fan motors will stop running. The refrigeration system will remain in defrost cycle for 45 minutes or until the evaporator coil reaches the safety termination temperature setting.

Carel 'ir33' Digital Temperature Control

Everest units are equipped with a Carel Digital Temperature Control. The type of controller is dependent on the model and production date.





Setting the Temperature

1. Press and hold Temperature Set Button  for 2 seconds until a number blinks on the LED. The blinking number is the current set temperature.
2. Toggle through the desired temperature by pressing UP  or DOWN . The number increases or decreases by a decimal point.
3. The recommended setting is 35.0°F (2.0°C) for refrigerators and -4.0°F (-20.0°C) for freezers. The available temperature setting range is 33.0°F to 54.0°F (1.0°C to 12.0°C) for Refrigerators and -10.0°F to 54.0°F (-23.0°C to 12.0°C) for Freezers.
4. Press and hold the Temperature Set Button  for 3 seconds to save the new temperature and exit the setting mode. The LED will return to the current cabinet temperature.

Initiating Manual Defrost

The controller has an automatic defrost cycle in place so initiating manual defrost is not necessary unless there is an abnormal accumulation of ice around the evaporator coil.

1. Press and hold down the Manual Defrost Button  until the Defrost Symbol  appears on the LED display.



The compressor, condenser and evaporator fan motors will stop running. The refrigeration system will remain in defrost cycle for 45 minutes or until the evaporator coil reaches the safety termination temperature setting.

6. Care and Maintenance

This section applies to all Everest products. Regular care and maintenance of your appliance will significantly extend service life and dependability. In severe cases, lack of upkeep will contribute to the rapid decline in performance and component health. Care and maintenance is the product owner's personal responsibility. Warranty is void if these guidelines are not met.

- Unplug the unit before cleaning, repairing or replacing parts.
- Do not spray the unit with water to avoid electric shock, component malfunction or the risk of fire.
- Do not use any flammable cleaning products on or around the unit to prevent the risk of fire.
- Do not use household or industrial chemical cleaners, acidic or chlorine based solutions, degreasers, wire brushes, scrapers, steel pads, acidic solutions or other abrasive products. These will damage the stainless steel's passivity layer resulting in advanced corrosion.
- The condenser coil builds up lint, dust and grease over time and will require monthly cleaning. Clogged condenser coils will result in decreased performance, advanced component failure and a risk of fire. See [page 17](#) for condenser coil cleaning instructions.
- Conduct regular inspection and cleaning of the door gaskets to ensure that they are sealing completely. Worn out or damaged gaskets will have gaps that will compromise cabinet temperature leading to possible food spoilage or component failure.
- Clean the interior surface of the unit with mild soap and warm water. Do not let water accumulate inside the unit. To prevent water damage, wipe the interior of the unit with a dry cloth as needed. Do not use steel wool, strong acids, concentrated detergents, bleaches, cleaning waxes, polishers and other abrasive cleaners. Do not allow moisture come in contact with electronic parts to avoid the risk of fire.
- Clean the exterior of the product with a stainless steel cleaner to restore the condition and passivation of the stainless steel surface. Do not use steel wool, strong acids, concentrated detergents, bleaches, cleaning waxes, polishers and other abrasive cleaners. Do not allow moisture come in contact with electronic parts to avoid the risk of fire.
- Acidic products and products containing vinegar must be stored in sealed containers to prevent acid damage to the interior of the unit and the evaporator coil. Rust resulting from improper maintenance is not covered under warranty.



Condenser Coil Cleaning Instructions

This section applies to all Everest products. The condenser coil requires monthly cleaning to keep the metal fins clear of lint, dust and grease build-up. A clogged condenser coil severely reduces your product's energy efficiency and places strain on the compressor and other components leading to advanced failure. Cleaning the condenser coil is the product owner's personal responsibility.

Warranty is void if the following guidelines are not met.

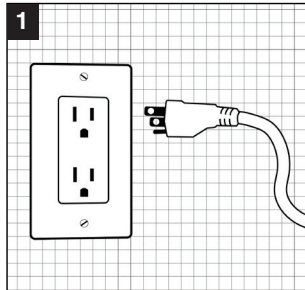

1. Disconnect the unit from the outlet before performing maintenance.

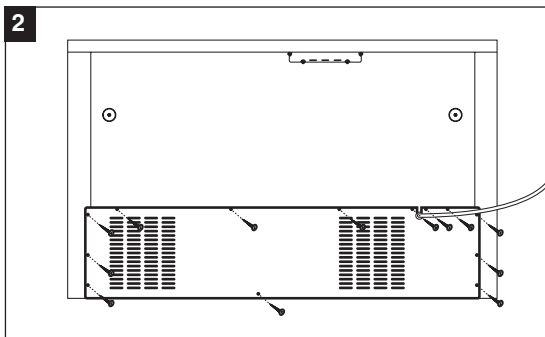

2. The condenser coil is behind the vented grill at the back of the unit.

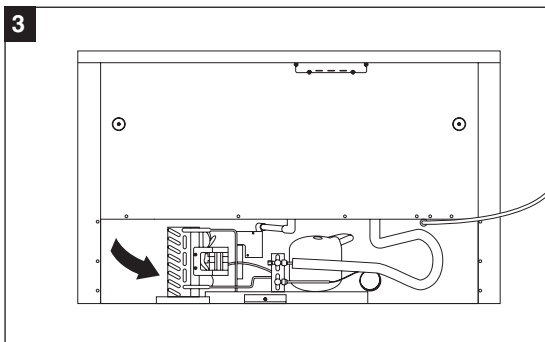

3 Remove all the screws from the back grill and detach completely.

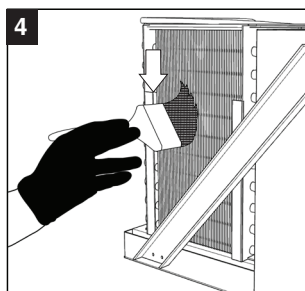

4. Use a long bristled brush in a vertical sweeping motion to remove lint, dust and debris from in between the metal fins of the condenser coil. Do not apply heavy pressure so as not to bend the fins.

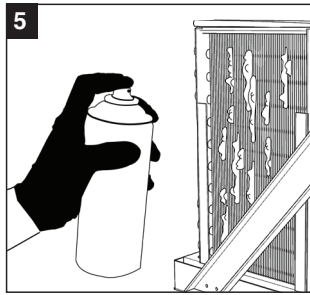

5. Use a commercial condenser coil cleaner for metal fins that are coated in grease. Allow the cleaner to saturate the area. Follow the recommended wait time printed on the product packaging.

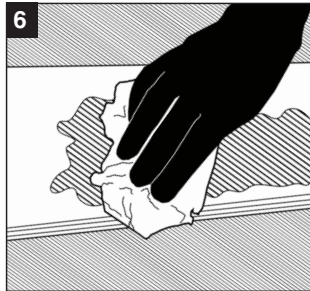

6. The grease and cleaning solvent will pool at the base of the metal fins. Brush the fins and wipe off any accumulated residue.



7. Repeat the above steps until the metal fins are clean. You should be able to see in through and in between the metal fins.

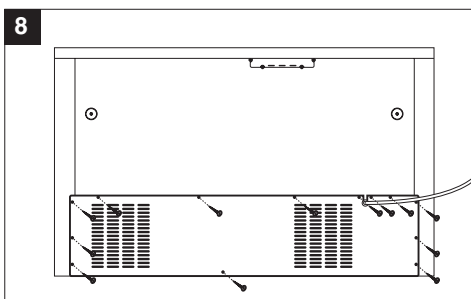

8. Screw in the back grill securely.

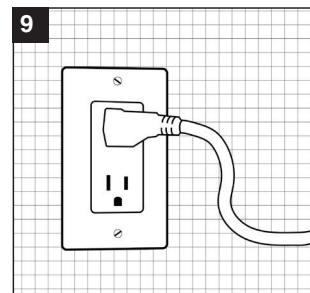

9. Reconnect the unit to the designated outlet.

Do not attach an aftermarket filter or screen around the condenser coil. This constricts ventilation which leads to overheating, component failure or the risk of fire.

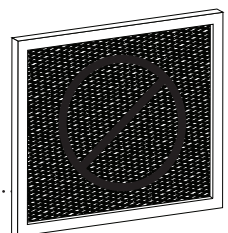

7. Troubleshooting Guide

In most cases, your Everest product may be exhibiting behavior that is typical of standard operation. Observe the following when troubleshooting symptoms.

'cht' or 'CHt' appears on the LED alternating with the current temperature and accompanied by an audible alarm.

The condenser coil may be clogged with dust, grime, or debris. Clean it following the instructions in [Chapter 6](#)

The room's ambient temperature may be higher than 86°F (30°C). Provide ample ventilation or additional cooling to the room or relocate the unit to a larger space with lower ambient temperature.

The unit may be installed in close proximity to heat sources such as ovens, stoves, heaters or direct sunlight. Relocate the unit away from these sources.

The unit may be installed without clearance or proper ventilation. Provide additional exhaust vents and observe the clearance allowance specified in [Chapter 1](#)

The compressor, fan motors, or entire system fails to start.

The ON/OFF switch may be set to OFF. Turn to the ON position and wait for the LED and motors to show signs of operation.

The power cord may not be connected. Check for proper connection. In cases of damage to the power cord or plug, immediately mark the unit as out of order until the damaged part is replaced.

The outlet may not be sending power or the power supply breaker may be switched off. Unplug the unit and contact a licensed electrician for inspection and/or repairs.

The compressor operates continuously or for prolonged periods.

The condenser coil may be clogged with dust, grime, or debris. Clean it following the instructions in [Chapter 6](#).

The door, drawer or gasket may not be sealing properly. Check product placement in the cabinet as it may prevent the door and drawers from fully closing. If the gasket is loose, reattach.

The evaporator coil may be blocked with ice. Defrost it following the instructions in [Chapter 7](#). Normally, evaporator coils will self-maintain with automated defrost cycles. If the evaporator coil ices up frequently, re-assess placement of food items in the cabinet as it could obstruct cold air circulation. Food items must not touch the wall or floors of the cabinet and stay within the boundaries of the shelf to prevent blockage of air flow.

The room's ambient temperature may be higher than 86°F (30°C). Provide ample ventilation or additional cooling to the room or relocate the unit to a larger space with lower ambient temperature.

The unit may be installed in close proximity to heat sources such as ovens, stoves, heaters or direct sunlight. Relocate the unit away from these sources.

The unit may be installed without clearance or proper ventilation. This forces the compressor to operate constantly in order to maintain cabinet temperature. Provide additional exhaust vents and observe the clearance allowance specified in [Chapter 3](#).

The cabinet temperature is too warm.

The condenser coil may be clogged with dust, grime or debris. Clean it following the instructions in [Chapter 6](#).

The door / drawer or gasket may not be sealing properly. Check product placement in the cabinet as it may prevent the door from fully closing. If the gasket is loose, reattach.

The temperature may be set too high. Adjust the setting to 35.0°F (2.0°C) for refrigerators or -4.0°F (-20.0°C) for freezers.

Hot food items may have been placed in the cabinet. Store only room temperature food items.

The room's ambient temperature may be higher than 86°F (30°C). Provide ample ventilation or additional cooling to the room. Relocate the unit from extremely small spaces without ventilation.

The unit may be installed in close proximity to heat sources such as ovens, stoves, heaters or direct sunlight. Relocate the unit away from these sources.

The unit may be installed without clearance or proper ventilation. Provide additional exhaust vents and observe the clearance allowance specified in [Chapter 3](#).

Food items are frosting over.

The temperature may be set too low. Adjust the setting to 35.0°F (2.0°C) for refrigerators or -4.0°F (-20.0°C) for freezers.

The placement of food items in the cabinet may be obstructing circulation of refrigerated air. This creates uneven temperature in the cabinet with pockets of very cold air that may cause items to frost or freeze over. Food items must not touch the wall or floors of the cabinet and stay within the boundaries of the shelf to prevent blockage of air flow.

Condensation in the interior cabinet.

The door / drawer or gaskets may not be sealing properly. If the gasket is loose, reattach. Check product placement in the cabinet as it may prevent the door from fully closing.

Hot food items may have been stored in the cabinet. The interaction between hot and cold temperatures will promote condensation.

Unsealed or open food items with high moisture content may have been stored in the cabinet. Keep these items in air tight containers.

Mild condensation in warmer ambient temperature conditions may occur due to frequent or prolonged door operation.

Condensation on the unit's exterior surfaces.

Highly humid environments will contribute to the condensation build up on exterior panels. Providing ample ventilation and air movement to a space will reduce the humidity level.

The door, drawer, or gasket may not be sealing properly. Check product placement in the cabinet as it may prevent the door from fully closing. If the gasket is loose, reattach.

Noise level during unit operation.

It is normal for commercial grade compressors and components to have a higher decibel output compared to residential counterparts.

The unit may not be balanced evenly. Poorly leveled units may cause components or fittings to misalign or disengage during operation. This may produce noise as a direct result of repeated surface friction or impact.

The unit may not be securely mounted to the floor. This may produce noise as a direct result of repeated surface friction or impact.

Some sounds are normal for the refrigeration process. A dripping sound, for example, is the result of refrigerant circulation during the compressor rest period.

8. Warranty Information

Register your Everest product within thirty (30) days of purchase to take full advantage of warranty services. Successful registration will expedite and help prevent complications in processing service requests.

Product Identification

The product data plate is a permanently affixed label that contains the model, serial, barcode numbers, and refrigeration data of your Everest product. This tag is located in the upper left or right interior compartment for models with doors, or the exterior left or right exterior housing for models with drawers. Please retain this information for service-related purposes.



EVEREST

 REFRIGERATION

Commercial
Refrigerators

MODEL : ETBR1

COMPRESSOR : 1/4 HP+

REFRIGERANT : R290

* Use of other than specified refrigerant voids warranty

REFRIGERANT CHARGE : 3.17 Oz

ELECTRICAL : 115VX1Phx60Hz

TOTAL AMPS : 3.27A (COMP RUN)

HIGH PRESSURE TEST : 218PSIG .

LOW PRESSURE TEST : 38PSIG .

* Do not clean label with solvent

Assembled in Korea



ETL LISTED
CONFORMS TO
ANSI/UL-471 CERTIFIED TO
CAN/CSA C22.2 NO. 120



9900932

Serial No:
BTBR1XXXXXXXXX

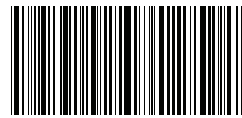

BB1KDO539A

Warranty Registration

You may register online at www.EVERESTref.com or send a completed warranty registration to:

**Everest Refrigeration
Warranty Department,
201 W. Artesia Blvd.,
Compton, CA 90220**

WARRANTY REGISTRATION CARD

3 Year Parts and Labor Warranty*

5 Year Compressor Warranty

Name of Business Owner : _____ Date : _____

Signature of Business Owner : _____

Business Name : _____ Telephone : _____

Street Address : _____

City : _____ State : _____ Zip : _____

Place of Purchase : _____ Date Purchased : _____ Date Installed : _____

Model No : _____ Cabinet Serial No : _____

** Terms may vary. Contact Everest for further details*

Warranty Certificate

Three (3) Year Labor & Parts Warranty

EVEREST warrants to the first purchaser of every new EVEREST unit, the cabinet and all parts thereof, to be free from defects in material or workmanship, under normal and proper use and maintenance service as specified by EVEREST and upon proper installation and start-up in accordance with the instruction packet supplied with each unit. Our obligation under this warranty is limited to a period of three (3)* years from the date of original installation or thirty six (36)* months after shipment date from EVEREST, whichever occurs first (applicable to units purchased after July 1, 2014). Any part covered under this warranty that is determined by EVEREST to have been defective within three (3)* years of original installation or thirty six (36)* months after shipment date from the manufacturer, whichever occurs first, is limited to the repair or replacement, including labor charges, of defective parts or assemblies. The labor warranty shall include standard straight time labor charges and reasonable travel time, as determined by EVEREST.

Five (5) Year Compressor Warranty

In addition to the warranty set forth above, EVEREST warrants the hermetically sealed compressor for five (5) years, not to exceed sixty (60) months from the unit's date of shipment from EVEREST.

Warranty Claims

All warranty claims for labor or parts must be made directly through EVEREST. All claims shall include: unit model number, cabinet serial number, proof of new product purchase, installation date, and all pertinent information related to the reported defect. To qualify for a compressor warranty claim, the replacement compressor must have been purchased directly from EVEREST. Claimants must submit the compressor warranty form and compressor tag to EVEREST. The compressor warranty does not apply to shipping and labor costs or other parts whether electrical or mechanical.

Warranty Exclusions

EVEREST's sole obligation under this warranty is limited to either the repair or replacement of parts, subject to the additional limitations below. This warranty neither assumes nor authorizes any person to assume obligations other than those expressly covered by this warranty.

- A. **NON WARRANTY PARTS.** EVEREST excludes specific parts exposed to normal wear and tear. These parts include, but are not limited to, lamps, gaskets, casters, shelves and shelf clips, pans, bin and pan dividers and airflow guards.
- B. **INDIRECT OR CONSEQUENTIAL DAMAGE.** EVEREST does not warrant economic loss, profit loss, or special, indirect or consequential damages including without limitation, losses or damages arising from food or product spoilage claims caused by refrigeration failure.
- C. **IMPROPER USAGE.** EVEREST is not responsible for parts or labor coverage for component failure and or other damages resulting from improper usage, installation or failure to clean and/or maintain the unit as set forth in the user's manual provided with this unit. All EVEREST units are designed for commercial use, not for residential use. Warranty is invalid if the unit is installed in a residence.
- D. **RELOCATION OF UNIT FOR REPAIR.** EVEREST is not responsible for the cost to move a unit for any reason from its position of operation on the customer's premises to make a warranty repair. Further, EVEREST is not responsible for the cost of disassembling cabinetry and/or panels built around the unit to make a warranty repair.
- E. **WARRANTY IS NOT TRANSFERRABLE.** Warranty is limited to only the original purchaser, owner or lessee of the unit. Warranty does not transfer with change of ownership or lessee.
- F. **ALTERATION, NEGLIGENCE, MISUSE, ABUSE, ACCIDENT, DAMAGE DURING TRANSIT OR INSTALLATION, FIRE, FLOOD, ACTS OF GOD.** EVEREST is not responsible for malfunctions due to alteration, neglect, misuse, abuse, accident, damage during transit or installation, fire, flood, storm, and/or other acts of God. EVEREST is not responsible for any improper electrical connections resulting from electrical power failure, the use of extension cords, and low voltage or voltage drops to the unit.
- G. **UNAUTHORIZED MODIFICATION.** EVEREST is not responsible for the repair or replacement of failed or damaged components resulting from unauthorized modifications to units or the use of non OEM parts without prior written approval from EVEREST.
- H. **IMPROPER ELECTRICAL CONNECTIONS.** EVEREST is not responsible for the repair or replacement of the unit or any damaged components resulting from incorrect supply voltage, low voltage, fluctuating supply voltage, incorrect amperage the use of extension cords, generators or other improper electrical connections.
- I. **OUTSIDE THE U.S.** This warranty does not apply to any parts and/or labor warranty claims made on units sold or used outside of the United States.

These warranties are exclusive and in lieu of all other warranties, expressed or implied, and all other obligations or liabilities on our part, and we neither assume nor authorize any other person to assume for us any other obligation or liability in connection with the sale of said refrigeration units or any part thereof.

**Terms may vary. Contact Everest for further details.*



E **REFRIGERATION**
EVEREST

A Step Above The Standard

201 W. Artesia Blvd., Compton, CA 90220

Tel 310-323-6586

Fax: 310-323-7524 / 310-761-1127

www.everestref.com

ver. 112818